



AIT 682: Network and Systems Security

Topic 4. Cryptographic Hash Functions

Instructor: Dr. Kun Sun



Outline

- Hash function lengths
- Hash function applications
- MD5 standard
- SHA-1 standard
- Hashed Message Authentication Code (HMAC)



Hash Function Properties

Hash Function

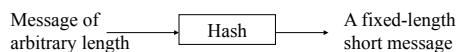

- Also known as
 - Message digest
 - One-way transformation
 - One-way function
 - Hash
- Length of $H(m)$ much shorter than length of m
- Usually fixed lengths: 128 or 160 bits

Desirable Properties of Hash Functions

- Consider a hash function H
 - Performance: Easy to compute $H(m)$
 - One-way property (preimage resistant): Given $H(m)$ but not m , it's computationally infeasible to find m
 - Weak collision resistant (2-nd preimage resistant): Given $H(m)$, it's computationally infeasible to find m' such that $H(m') = H(m)$.
 - Strong collision resistant (collision resistant): Computationally infeasible to find m_1, m_2 such that $H(m_1) = H(m_2)$

Length of Hash Image

- Question
 - Why do we have 128 bits or 160 bits in the output of a hash function?
 - If it is too long
 - Unnecessary overhead
 - If it is too short
 - Birthday paradox
 - Loss of strong collision property

Birthday Paradox

- Question:
 - What is the smallest group size k such that
 - The probability that at least two people in the group have the same birthday is greater than 0.5?
 - Assume 365 days a year, and all birthdays are equally likely
 - P(k people having k different birthdays):
 $Q(365, k) = 365! / (365 - k)! 365^k$
 - P(at least two people have the same birthday):
 $P(365, k) = 1 - Q(365, k) \approx 0.5$
 - k is about 23

7

Birthday Paradox (Cont'd)

- Generalization of birthday paradox
 - Given
 - a random integer with uniform distribution between 1 and n , and
 - a selection of k instances of the random variables,
 - What is the least value of k such that
 - There will be at least one duplicate
 - with probability $P(n, k) > 0.5$, ?

8

Birthday Paradox (Cont'd)

- Generalization of birthday paradox
 - $P(n, k) \approx 1 - e^{-k(k-1)/2n}$
 - For large n and k , to have $P(n, k) > 0.5$ with the smallest k , we have
 - Example $k = \sqrt{2(\ln 2)n} = 1.18\sqrt{n} \approx \sqrt{n}$
 - $1.18 * (365)^{1/2} = 22.54$

9

Birthday Paradox (Cont'd)

- Implication for hash function H of length m
 - With probability at least 0.5
 - If we hash about $2^{m/2}$ random inputs,
 - Two messages will have the same hash image
 - Birthday attack
- Conclusion
 - Choose $m \geq 128$

10

Hash Function Applications

Application: File Authentication

- Want to detect if a file has been changed by someone after it was stored
- Method
 - Compute a hash $H(F)$ of file F
 - Store $H(F)$ separately from F
 - Can tell at any later time if F has been changed by computing $H(F')$ and comparing to stored $H(F)$
- Why not just store a duplicate copy of F???

12

Application: User Authentication

- Alice wants to authenticate herself to Bob
 - assuming they already **share a secret key K**
- Protocol:

13

User Authentication... (cont'd)

- Why not just send...
 - ...K, in plaintext?
 - ...H(K)? , i.e., what's the purpose of R?

14

Application: Commitment Protocols

- Ex.: A and B wish to play the game of "odd or even" over the network
 - A picks a number X
 - B picks another number Y
 - A and B "simultaneously" exchange X and Y
 - A wins if X+Y is odd, otherwise B wins
- If A gets Y before deciding X, A can easily cheat (and vice versa for B)
 - How to prevent this?

15

Commitment... (Cont'd)

- Proposal: A must **commit** to X **before** B will send Y
- Protocol:

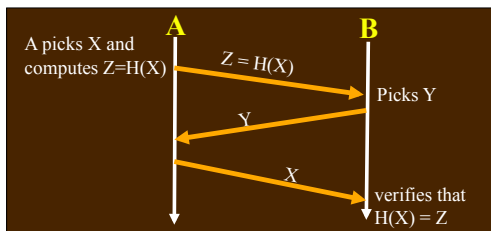

- Can either A or B successfully cheat now?

16

Commitment... (Cont'd)

- Why is sending $H(X)$ better than sending X ?
- Why is sending $H(X)$ good enough to prevent A from cheating?
- Why is it not necessary for B to send $H(Y)$ (instead of Y)?
- What problems are there if:
 1. The set of possible values for X is **small**?
 2. B can **predict** the next value X that A will pick?

17

Application: Message **Encryption**

- Assume A and B share a secret key K
 - but don't want to just use encryption of the message with K
- A sends B the (encrypted) random number R_1 ,
B sends A the (encrypted) random number R_2
- And then...

18

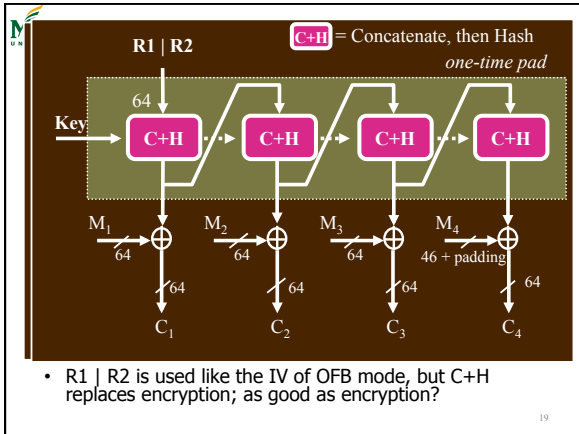

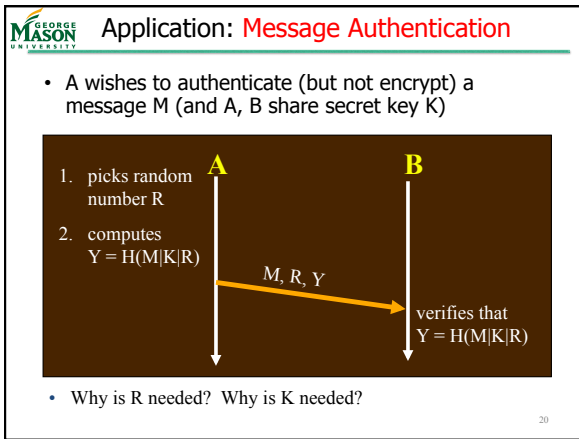

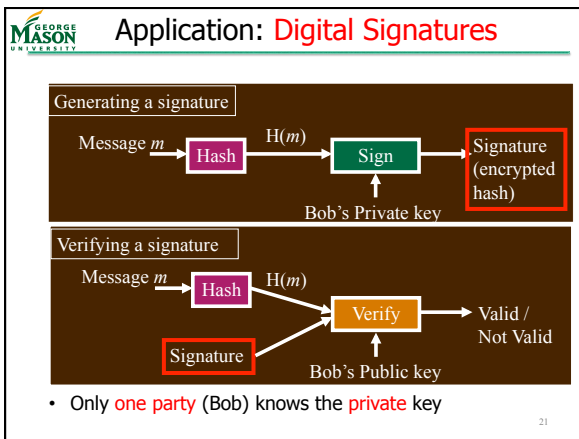

GEORGE MASON UNIVERSITY Is Encryption a Good Hash Function?

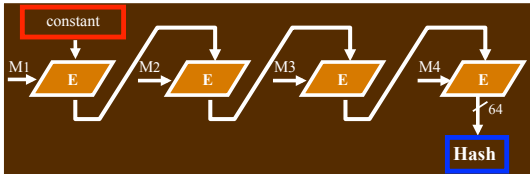

- Building hash using block chaining techniques
 - Encryption block size may be too short (DES=64)
 - Birthday attack
 - Can construct a message with a particular hash fairly easily
 - Extension attacks

GEORGE MASON UNIVERSITY Hash Using Block Chaining Techniques

- Meet-in-the-middle attack
 - Get the correct hash value G
 - Construct any message in the form Q_1, Q_2, \dots, Q_{n-2}
 - Compute $H_i = E_{Q_i}(H_{i-1})$ for $1 \leq i \leq (n-2)$.
 - Generate $2^{m/2}$ random blocks; for each block X, compute $E_X(H_{n-2})$.
 - Generate $2^{m/2}$ random blocks; for each block Y, compute $D_Y(G)$.
 - With high probability there will be an X and Y such that $E_X(H_{n-2}) = D_Y(G)$.
 - Form the message $Q_1, Q_2, \dots, Q_{n-2}, X, Y$. It has the hash value G.

GEORGE MASON UNIVERSITY Modern Hash Functions

- MD5
 - Previous versions (i.e., MD2, MD4) have weaknesses.
 - Broken; collisions published in August 2004
 - Too weak to be used for serious applications
- SHA (Secure Hash Algorithm)
 - Weaknesses were found
- SHA-1
 - Broken, but not yet cracked
 - Collisions in 2^{69} hash operations, much less than the brute-force attack of 2^{80} operations
 - Results were circulated in February 2005, and published in CRYPTO '05 in August 2005
- SHA-2 (SHA-256, SHA-384, ...)

MD5 Hash Function

MD5: Message Digest Version 5

- MD5 at a glance

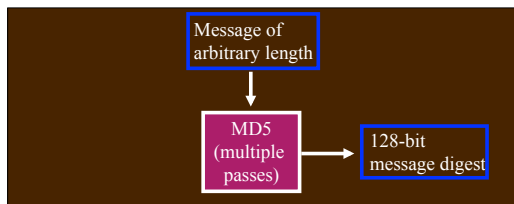

Processing of A Single Block

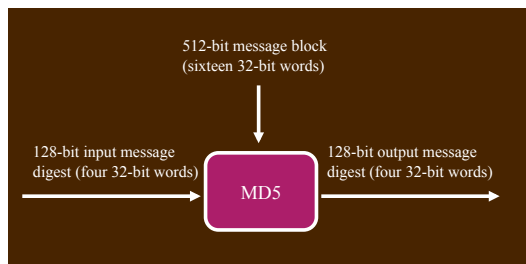

Called a compression function

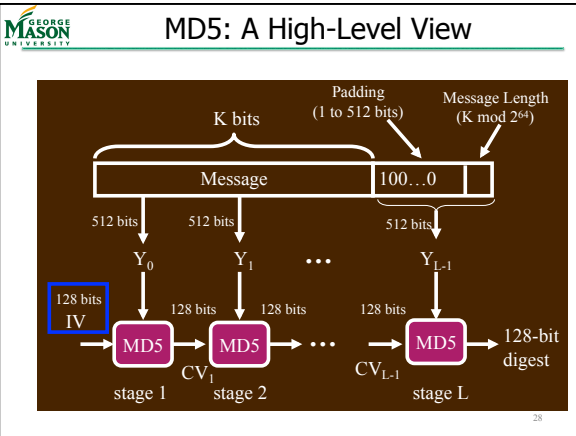

- Padding**
- There is always padding for MD5, and padded messages must be **multiples of 512 bits**
 - To original message M , add padding bits "10...0"
 - enough 0's so that resulting total length is 64 bits less than a multiple of 512 bits
 - Append L (original length of M), represented in 64 bits, to the padded message
 - Footnote: the bytes of each 32-bit word are stored in **little-endian order** (LSB to MSB)

- Padding... (cont'd)**
- How many 0's if length of $M =$
 - $n * 512?$
 - $n * 512 - 64?$
 - $n * 512 - 65?$

Preliminaries

- The four 32-bit words of the output (the *digest*) are referred to as **d0, d1, d2, d3**
- Initial values (in little-endian order)
 - **d0** = 0x67452301
 - **d1** = 0xEFCDAB89
 - **d2** = 0x98BADCFE
 - **d3** = 0x10325476
- The sixteen 32-bit words of each message block are referred to as **m0, ..., m15**
 - (16*32 = 512 bits in each block)

31

Notation

- $\sim x$ = bit-wise complement of x
- $x \wedge y$, $x \vee y$, $x \oplus y$ = bit-wise AND, OR, XOR of x and y
- $x \ll y$ = left circular shift of x by y bits
- $x + y$ = arithmetic sum of x and y (discarding carry-out from the msb)
- $\lfloor x \rfloor$ = largest integer less than or equal to x

32

Processing a Block-Overview

- Every message block Y_i contains **16 32-bit words**:
 - $m_0, m_1, m_2, \dots, m_{15}$
- A block is processed in **4** consecutive passes, each modifying the MD5 buffer d_0, \dots, d_3 .
 - Called F, G, H, I
- Each pass uses one-fourth of a 64-element table of constants, $T[1..64]$
 - $T[i] = \lfloor 2^{32} * \text{abs}(\sin(i)) \rfloor$, represented in 32 bits
- Output digest = input digest + output of 4th pass

33

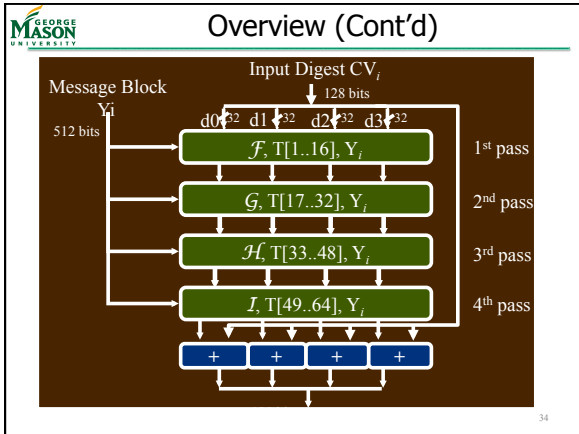

1st Pass of MD5

- $\mathcal{F}(x, y, z) \stackrel{\text{def}}{=} (x \wedge y) \vee (\sim x \wedge z)$
- 16 processing steps, producing $d_0..d_3$ output:

$$d_i = d_j + (d_k + \mathcal{F}(d_l, d_m, d_n) + m_o + T_p) \lll s$$

– values of subscripts, in this order

i	j	k	l	m	n	o	p	s
0	1	0	1	2	3	0	1	7
3	0	3	0	1	2	1	2	12
2	3	2	3	0	1	2	3	17
1	2	1	2	3	0	3	4	22
0	1	0	1	2	3	4	5	7

35

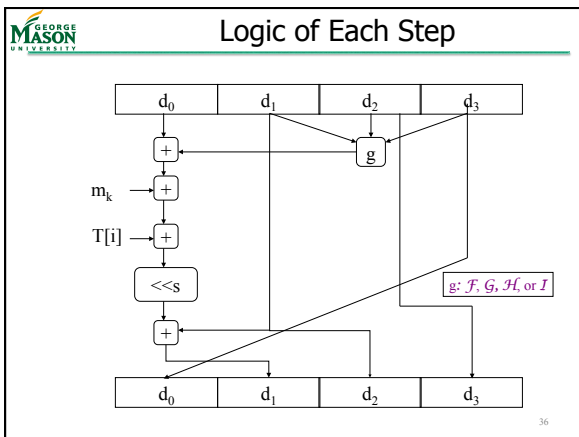

Logic of Each Step (Cont'd)

- Within each pass, each of the 16 words of m_i is used exactly once
 - Round 1, m_i are used in the order of i
 - Round 2, in the order of $\rho_2(i)$, where $\rho_2(i)=(1+5i) \bmod 16$
 - Round 3, in the order of $\rho_3(i)$, where $\rho_3(i)=(5+3i) \bmod 16$
 - Round 4, in the order of $\rho_4(i)$, where $\rho_4(i)=7i \bmod 16$
- Each word of $T[i]$ is used exactly once throughout all passes
- Number of bits s to rotate to get d_i
 - Round 1, $s(d_0)=7, s(d_1)=22, s(d_2)=17, s(d_3)=12$
 - Round 2, $s(d_0)=5, s(d_1)=20, s(d_2)=14, s(d_3)=9$
 - Round 3, $s(d_0)=4, s(d_1)=23, s(d_2)=16, s(d_3)=11$
 - Round 4, $s(d_0)=6, s(d_1)=21, s(d_2)=15, s(d_3)=10$

37

2nd Pass of MD5

- $G(x,y,z) \stackrel{\text{def}}{=} (x \wedge z) \vee (y \wedge \sim z)$
- Form of processing (16 steps):

$$\mathbf{d}_i = \mathbf{d}_j + (\mathbf{d}_k + G(\mathbf{d}_l, \mathbf{d}_m, \mathbf{d}_n) + \mathbf{m}_o + T_{\rho})$$

$$\lll s$$

i	j	k	l	m	n	o	p	s
0	1	0	1	2	3	1	17	5
3	0	3	0	1	2	6	18	9
2	3	2	3	0	1	11	19	14
1	2	1	2	3	0	0	20	20
0	1	0	1	2	3	5	21	5

⋮

38

3rd Pass of MD5

- $\mathcal{H}(x,y,z) \stackrel{\text{def}}{=} (x \oplus y \oplus z)$
- Form of processing (16 steps):

$$\mathbf{d}_i = \mathbf{d}_j + (\mathbf{d}_k + \mathcal{H}(\mathbf{d}_l, \mathbf{d}_m, \mathbf{d}_n) + \mathbf{m}_o + T_{\rho})$$

$$\lll s$$

i	j	k	l	m	n	o	p	s
0	1	0	1	2	3	5	33	4
3	0	3	0	1	2	8	34	11
2	3	2	3	0	1	11	35	16
1	2	1	2	3	0	14	36	23
0	1	0	1	2	3	1	37	4

⋮

39

4th Pass of MD5

- $I(x,y,z) \stackrel{\text{def}}{=} y \oplus (x \vee \sim z)$
- Form of processing (16 steps):

$$\mathbf{d}_i = \mathbf{d}_j + (\mathbf{d}_k + I(\mathbf{d}_l, \mathbf{d}_m, \mathbf{d}_n) + \mathbf{m}_o + T_p) \lll S$$

<i>i</i>	<i>j</i>	<i>k</i>	<i>l</i>	<i>m</i>	<i>n</i>	<i>o</i>	<i>p</i>	<i>s</i>
0	1	0	1	2	3	0	49	6
3	0	3	0	1	2	7	50	10
2	3	2	3	0	1	14	51	15
1	2	1	2	3	0	5	52	21
0	1	0	1	2	3	12	53	6

- Output of this pass added to input MD

(In)security of MD5

- A few recently discovered methods can find collisions in a few hours
 - A few collisions were published in 2004
 - Can find many collisions for 1024-bit messages
 - More discoveries afterwards
 - In 2005, two X.509 certificates with different public keys and the same MD5 hash were constructed
 - This method is based on differential analysis
 - 8 hours on a 1.6GHz computer
 - Much faster than birthday attack

SHA-1 Hash Function



Secure Hash Algorithm (SHA)

- Developed by NIST, specified in the Secure Hash Standard, 1993
- SHA is specified as the hash algorithm in the Digital Signature Standard (DSS)
- SHA-1: revised (1995) version of SHA

43



SHA-1 Parameters

- Input message must be $< 2^{64}$ bits
- Input message is processed in 512-bit blocks, with the same padding as MD5
- Message digest output is **160** bits long
 - Referred to as five 32-bit words **A, B, C, D, E**
 - **IV: A** = 0x67452301, **B** = 0xEFCDAB89, **C** = 0x98BADCFE, **D** = 0x10325476, **E** = 0xC3D2E1F0
- Footnote: bytes of words are stored in big-endian order

44



Big Endian vs. Little Endian

- A 32-bit word can be saved in 4 bytes
 - For instance, **90AB12CD₁₆**

- Big Endian

Address	Value
1000	90
1001	AB
1002	12
1003	CD

- Little Endian

Address	Value
1000	CD
1001	12
1002	AB
1003	90

45

Preprocessing of a Block

- Let 512-bit block be denoted as sixteen 32-bit words $W_0..W_{15}$
- Preprocess $W_0..W_{15}$ to derive an additional sixty-four 32-bit words $W_{16}..W_{79}$, as follows:

for $16 \leq t \leq 79$

$$W_t = (W_{t-16} \oplus W_{t-14} \oplus W_{t-8} \oplus W_{t-3}) \lll 1$$

46

Block Processing

- Consists of 80 steps! (vs. 64 for MD5)
- Inputs for each step $0 \leq t \leq 79$:
 - W_t
 - K_t – a constant
 - A, B, C, D, E : current values to this point
- Outputs for each step:
 - A, B, C, D, E : new values
- Output of last step is added to input of first step to produce 160-bit Message Digest

47

Constants K_t

- Only 4 values (represented in 32 bits), derived from $2^{30} * i^{1/2}$, for $i = 2, 3, 5, 10$
 - for $0 \leq t \leq 19$: $K_t = 0x5A827999$ ($i=2$)
 - for $20 \leq t \leq 39$: $K_t = 0x6ED9EBA1$ ($i=3$)
 - for $40 \leq t \leq 59$: $K_t = 0x8F1BBCDC$ ($i=5$)
 - for $60 \leq t \leq 79$: $K_t = 0xCA62C1D6$ ($i=10$)

48

Function $f(t,B,C,D)$

- 3 different functions are used in SHA-1 processing

Round	Function $f(t,B,C,D)$	Compare with MD-5
$0 \leq t \leq 19$	$(B \wedge C) \vee (\sim B \wedge D)$	$\mathcal{F} = (x \wedge y) \vee (\sim x \wedge z)$
$20 \leq t \leq 39$	$B \oplus C \oplus D$	$\mathcal{H} = x \oplus y \oplus z$
$40 \leq t \leq 59$	$(B \wedge C) \vee (B \wedge D) \vee (C \wedge D)$	
$60 \leq t \leq 79$	$B \oplus C \oplus D$	$\mathcal{H} = x \oplus y \oplus z$

- No use of MD5's $\mathcal{G}((x \wedge z) \vee (y \wedge \sim z))$ or $\mathcal{I}(y \oplus (x \vee \sim z))$

49

Processing Per Step

- Everything to right of "=" is input value to this step

```

for t = 0 upto 79
  A = E + (A << 5) + Wt + Kt + f(t, B, C, D)
  B = A
  C = B << 30
  D = C
  E = D
endfor

```

50

Comparison: SHA-1 vs. MD5

- SHA-1 is a stronger algorithm
 - brute-force attacks require on the order of 2^{80} operations vs. 2^{64} for MD5
- SHA-1 is about twice as expensive to compute
- Both MD-5 and SHA-1 are **much** faster to compute than DES

51

Security of SHA-1

- SHA-1
 - output 160 bits
 - “Broken”, but not yet cracked
 - Collisions in 2^{69} hash operations, much less than the brute-force attack of 2^{80} operations
 - Results were circulated in February 2005, and published in CRYPTO '05 in August 2005
 - Considered insecure for collision resistance
 - One-way property still holds
- SHA-2(SHA-224, SHA-256, SHA-384, SHA-512...)

52

SHA-3 is coming

- NIST is having an ongoing competition for SHA-3, the next generation of standard hash algorithms
 - 2007: Request for submissions of new hash functions
 - 2008: Submissions deadline. Received 64 entries. Announced first-round selections of 51 candidates.
 - 2009: After First SHA-3 candidate conference in Feb, announced 14 Second Round Candidates in July.
 - 2010: After one year public review of the algorithms, hold second SHA-3 candidate conference in Aug. Announced 5 Third-round candidates in Dec.
 - 2011: Public comment for final round
 - 2012: Held Final hash candidate conference on March 22-23. Draft standard, wait for comments, and submit recommendation.
- The winning algorithm, **Keccak**, was created by Guido Bertoni, Joan Daemen and Gilles Van Assche of STMicroelectronics and Michaël Peeters of NXP Semiconductors.

53

Hashed Message Authentication Code (HMAC)

Extension Attacks

- Given M_1 , and secret key K , can easily concatenate and compute the hash: $H(K|M_1|padding)$
- Given M_1 , M_2 , and $H(K|M_1|padding)$ easy to compute $H(K|M_1|padding|M_2|newpadding)$ for some new message M_2
- Simply use $H(K|M_1|padding)$ as the IV for computing the hash of $M_2|newpadding$
 - does not require knowing the value of the secret key K

55

Extension Attacks (Cont'd)

- Many proposed solutions to the extension attack, but **HMAC** is the standard
- Essence: digest-inside-a-digest, with the secret used at both levels
- The particular hash function used determines the length of the message digest
digest = length of HMAC output

56

HMAC Processing

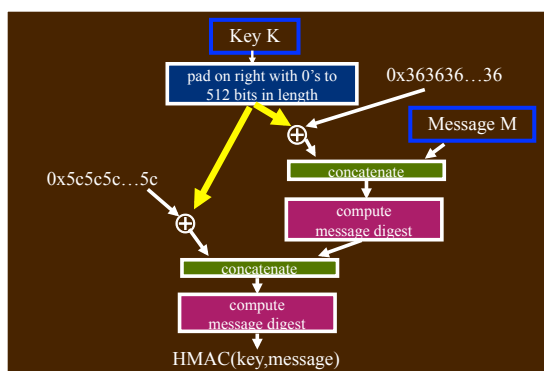



Security of HMAC

At high level, $\text{HMAC}_K[M] = H(K \parallel H(K \parallel M))$

- If used with a secure hash functions (e.g., SHA-256) and according to the specification (key size, and use correct output), no known practical attacks against HMAC

58



Summary

- Hashing is fast to compute
- Has many applications (some making use of a secret key)
- Hash images must be at least 128 bits long
 - but longer is better
- Hash function details are tedious ☹
- HMAC protects message digests from extension attacks
